

**Mini (7/8) 3 pole, Female 90° w/ Cable,**

TPE, TC-ER+FT4, 3x16AWG, yellow, 5m

Female 90°

7/8" (3-pole)

Power cable

USA

without cable sleeves

Further cable lengths on request.

Plastic housings with good resistance against chemicals and oils.

The resistance to aggressive media should be individually tested for your application. Further details on request.

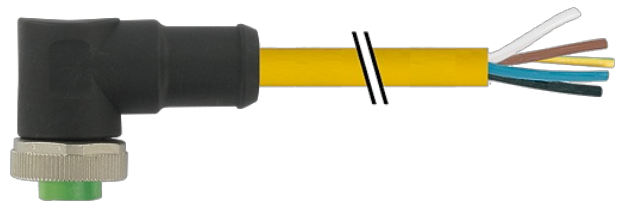
**[Link to Product](#)****Illustration**

Product may differ from Image

**Approvals**

\* only for products with UL/CSA approved cable

**Form**

Form A3031

**General data**

Mounting method	inserted, tightened
Pollution Degree	3
Temperature range	-25...+80 °C, depending on cable quality

**Cables**

No./diameter of wires	3x 1.5 mm <sup>2</sup>
Wire isolation	PVC (bk, gn, wh)
Material (jacket)	TPE (UL/CSA)
Outer Ø	8.4 mm ±5%
Bend radius (moving)	10x outer Ø
Temperature range (fixed)	-50...+105 °C
Temperature range (mobile)	-20...+90 °C
Cable identification	U1B
Approval (cable)	UL (AWM-Style 21002/1841), CSA
Cable weight [g/m]	115,50
Material (wire)	Cu wire, bare
Resistor (core)	max. 13.2 Ω/km (20 °C)
Single wire Ø (core)	0.16 mm

Construction (core)	65× 0.16 mm (multi-strand wire class 6)
AWG	similar to AWG 16
Material (wire isolation)	PVC
Wire-Ø incl. isolation	2.6 mm ±5%
Color/numbering of wires	bk, gn, wh
Shield	no
Material (jacket)	TPE
Outer-Ø (jacket)	8.4 mm ±5%
Color (jacket)	yellow
chemical resistance	good resistance to oil, gasoline and chemicals
thermal resistance	flame retardant UL, FT4
Nominal voltage	600 V
Test voltage	6 kV spark test
Current load capacity	NEC (National Electric Code)
Temperature range (fixed)	-50...+105 °C
Temperature range (mobile)	-20...+90 °C
Bend radius (fixed)	8× outer Ø
Bend radius (moving)	10× outer Ø
Torsion stress	±90 °/m
No. of torsion cycles	2 Mio.
Jacket Color	yellow

#### Technical Data

Operating voltage	max. 600 V AC/DC
Rated surge voltage	4.0 kV
Operating current per contact	max. 12 A
No. of poles	3
LED display	no
Locking of ports	Screw thread 7/8" (recommended torque 1.5 Nm) self-securing
Compression gland	7/8" (SW24)
Protection	IP68 inserted and tightened (EN 60529)
Locking material	Zinc die casting, matte nickel plated
Material	PUR

#### Commercial data

country of origin	DE
customs tariff number	85444290
EAN	4048879645287
eClass	27279218
Packaging unit	1

#### Sketch

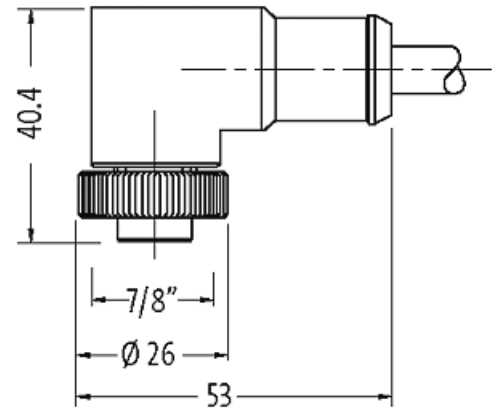

Female

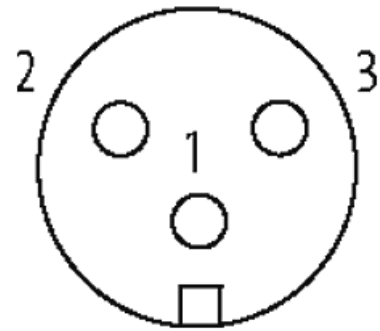

Product may differ from Image